



MAKING IMPOSSIBLE POSSIBLE

TMS RESEARCH

Offering turnkey solutions for a wide range of applications, including interleaved TMS/fMRI, double-blinded clinical research, translational research, robotic, and neuronavigated solutions.

MagVenture *TMS Research*
Making impossible possible.

INDEX

PAGE 04

Interleaved TMS/fMRI

PAGE 06

Clinical TMS research studies

PAGE 08

Neuronavigated TMS solutions with Localite

PAGE 10

Robotic TMS solutions with Axilum Robotics

PAGE 12

Translational research

PAGE 13

Tailored research solutions

PAGE 14

Stimulate multiple sites at the same time

PAGE 15

Introducing the XP: MagVenture's most powerful stimulator

PAGE 15

Sneak peak into the future

PAGE 16

Stimulator overview

PAGE 17

Coil overview

Ø 116

39

The world of TMS research is dynamic and fascinating. Only due to the hard and groundbreaking research done around the globe has TMS progressed to the widespread adoption we are seeing today.

MagVenture has been committed to TMS research since its inception 30 years ago by chief engineer and CEO, Stig Wanding Andersen. MagVenture has, since the very beginning, engaged in long-term, close collaborations with numerous high-ranking neuroscience research institutions and facilities worldwide, allowing scientists to continuously challenge and push the limits of TMS.

This presentation takes you through some of our many advanced neuromodulation systems, ranging from a turnkey solution for interleaved TMS/fMRI, over double-blinded research systems, to translational research, robotic, and neuronavigated solutions.

We have a passion for innovative solutions and work hard every day to solve even the most demanding requests, ultimately helping researchers gain an even deeper understanding of the human brain and develop future clinical applications that will benefit millions of patients.

That's why we say "Making Impossible Possible".

1.6

Exterior surfaces



Interleaved TMS/fMRI

Study human brain functionality in real-time

With this complete turnkey TMS/fMRI research solution, it is possible to induce neural activity safely into targeted cortical regions, directly in the MRI scanner. Features of the MagVenture TMS/fMRI solution further include:

- Special TMS coils for use inside the MRI scanner
- Reduced RF noise filters and controllers
- Built-in dynamic leakage current reduction for minimizing artefacts
- Stimulator-controlled recharge delay and parameters
- High quality imaging
- Ability to add inside/inbore neuronavigation
- Full control via synchronization of TMS, scanner and peripheral equipment, incl. neuronavigation and functional data formats (Analyze, DICOM, MNI, IFTI)
- EEG electrode localization and position export in flexible data format
- Export of stimulation parameters (e.g. EMG, amplitude, mapping results) along with the acquired stimulation location as functional image data
- Open documentation format: All data stored is written in XML format for easy post processing
- The MRI compatible solution can easily be extended to a 2-in-1 solution for navigation outside the MRI environment

A dedicated 7-channel coil array

For high sensitivity TMS/fMRI, particularly at the stimulation site, a dedicated 7-channel, ultra-slim RF coil array may be used with both of MagVenture's MRI coils, further adding:

- Improved signal-to-noise ratio over a traditional birdcage MRI head coil
- Enhanced coil position flexibility

Developed in collaboration with leading MRI centers around the world. More than 50 active TMS/fMRI installations globally, resulting in at least 15 published studies so far.



The 7-channel coil array was developed in close collaboration with the Medical University of Vienna and provides excellent image quality.

Recommended interleaved TMS/fMRI solution

- **Stimulator:** R30, R30 MO, X100, X100 MO or XP Orange Edition, depending on application
- **Coils:** MRI-B91 Air Cooled or MRI-B91 (uncooled)
Two dedicated 7-channel coil arrays or a birdcage
- **Coil holder:** Dedicated coil holder for optimal positioning
- **Filter:** RF Filter with neuronavigation

Uninterrupted operation program

MagVenture offers a special plan and program for re-provisioning of MRI coils providing a solution for uninterrupted system uptime at a fixed cost*.



I've seen it turn from a DIY project to a works-straight-out-of-the-box system by MagVenture. We see virtually no artefacts related to the MR compatible TMS coil. RF noise is very well dealt with by the filter provided. The setup is also a painless procedure, with MagVenture experts coming to help with all aspects of installation and first use. The TMS coil holder is a handy design, and we no longer have to design and manufacture our coil holders in house like we used to!

- Dr. Eva Feredoes, University of Reading, UK

*May not be available in your region. Please consult with your national MagVenture representative.

Clinical TMS research studies

The most comprehensive solution for double-blinded TMS studies

MagVenture offers a highly flexible solution which addresses all your requirements for accuracy, reliability, and consistency in clinical research and thus, ultimately, helps facilitate new treatment options. This even includes the possibility to perform true randomized, double-blinded, multi-center studies. A robotic solution and/or neuronavigation may easily be added to further enhance the reproducibility of your research.

- Coils with both active and sham sides (or with only a placebo side)
- Software for complete study control by study master or principal investigator
- Patient and operator codes to ensure true double-blinding
- Sham noise generation
- Electric masking



MagVenture's Clinical TMS Research solution is an advanced option for researchers interested in doing double-blinded research studies.

**More than 250 clinical solutions
with active/placebo coils sold,
resulting in 16 studies so far.**



MagVenture offers a number of coils with both an active and a placebo side. Combined with advanced software, neither the operator nor the patient knows who receives real TMS treatment and who receives sham treatment.

Recommended solution for Clinical TMS research

- **Stimulators:** R30, R30 MO, X100 or X100 MO depending on application
- **Active/Placebo coils:** Cool-B65 A/P, Cool-B70 A/P, Cool D-B80 A/P, MMC-140 A/P, Cool-B65 A/P RO.
- **Accessory:** Coil Cooler Unit or High-Performance Coil Cooling System.
- **Software:** MagVenture Double-Blinded Research Studies software.

Need a single-blinded research solution?

If you only need a placebo coil for your research, MagVenture offers these three coil options: MC-P-B70, MCF-P-B70 and MCF-P-B65.

Neuronavigated TMS solutions with Localite

Stimulate selected brain regions with high precision and reliability every time

Plan stimulation areas, visualize the stimulation spot, and monitor and record the precise position of the research subject and coil with complete reproducibility. The turnkey solution provides full integration with MagVenture stimulators, allowing for automatic and easy exchange of all the needed information such as intensity, coil and stimulator type, MEPs, and temperature.

- Easily scalable: From MR-less system to MR-based system extendable by attractive software and hardware
- Tracking of up to 4 coils at the same time
- More than 30 MagVenture coils ready to use in the software
- Import multiple morphological and functional data formats (Analyze, DICOM, MNI, NIFTI)
- EEG electrode localization and position export in flexible data format
- Export of stimulation parameters (e.g. EMG, amplitude, mapping results), along with the acquired stimulation location as functional image data
- Open documentation format: All stored data is written in XML format for easy post processing
- The MRI compatible solution can easily be extended to a 2-in-1 solution for navigation outside the MRI environment



Localite TMS Navigator comes along as a complete ready-to-use system including a broad range of tracking tools.



Perform neuronavigated TMS inside the MRI scanner (hardware tested and certified by an accredited laboratory).

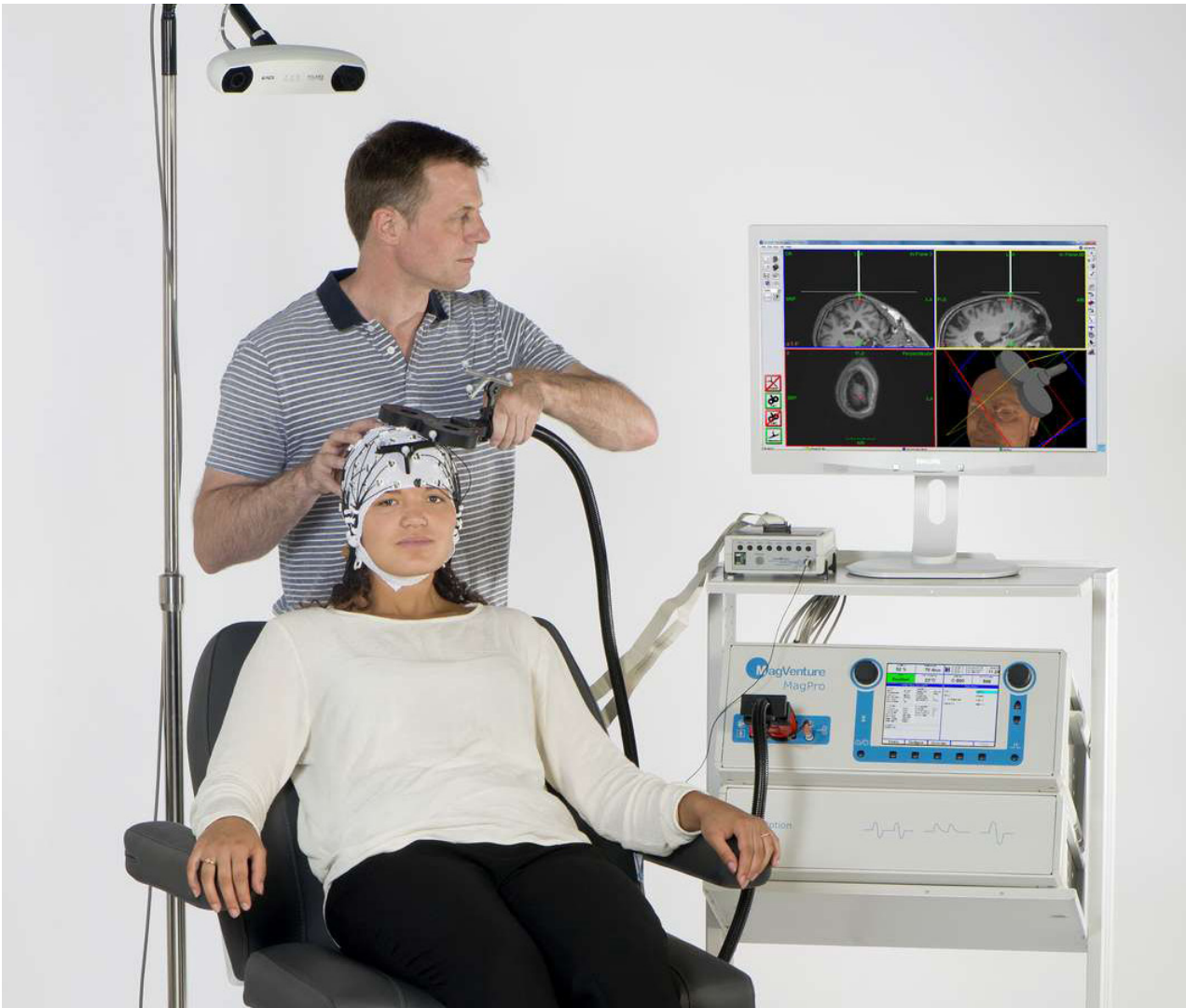

Neuronavigated TMS options

Depending on your research needs, Localite offers a range of different neuronavigation systems that are precise, intuitive, and scalable.

TMS Navigator Classic Line

- Full-featured navigation systems, based on a small or large format camera

TMS Navigator MR-compatible Edition

- Navigated stimulation inside the MR scanner

TMS Navigator Robotic Edition for Axilum Robot or Cobot

- Automatic and safe coil positioning with Axilum Robotics TMS Robot

Recommended TMS research setup

- MagVenture stimulator (R30-X100, depending on your needs)
- 35+ coil selections depending on the application, including active/placebo coils for clinical research studies
- Coil Cooler Unit or High-Performance Coil Cooling System depending on the application

Robotic TMS solutions with Axilum Robotics

Movement controlled, highly accurate TMS without compromising on safety or comfort

Head motion compensation monitors the coil's position, orientation, and contact to the head at all times and actively follows any possible head movement during TMS. It ensures a high level of repeatability between TMS sessions, is integrable with MagVenture stimulators and coils, and may be piloted by a neuronavigation system from Localite.

- Maintain position, orientation, and tilt of the TMS coil during the session
- Compensate for potential head motion during the TMS session
- Maintain contact between coil and head (integrated contact sensor)
- Plan fully-automated image-guided TMS sessions when piloted by a compatible neuronavigation system
- Plan and execute predefined stimulation paths when piloted by a compatible neuronavigation system
- Ensure identical setups in multi-center studies
- Reduce inter-operator variability
- Double-blind study support
- Reduce interactions between operator and patient during the session (no need for coil adjustment)



Both the TMS-Cobot and the TMS-Robot are CE marked medical devices. The TMS-Cobot is FDA cleared for the spatial positioning and orientation of the treatment coil of the MagVenture TMS Therapy® system.



Robotic TMS options

There are two different solutions available to meet your requirements. Whichever you choose depends on your needs.

TMS-Robot: High-end robot system for advanced brain research.
3 dedicated TMS coils: Cool-B65 A/P RO, Cool-B65 RO, Cool-B35 RO

- Optimized workspace with 7 axis arm and patented hemispherical architecture suitable for extended multisite stimulation
- Pilotable by compatible neuronavigation system

TMS-Cobot: Smaller system optimized for clinical use.
2 dedicated TMS coils: Cool-B65 A/P CO and Cool-B65 CO

- Collaborative robotic technology
- Pilotable by either Axilum Robotics' optical Tracking system (no MRI guidance) or compatible neuronavigation system (MRI guidance)
- Suitable for research when extended workspace is not required

Translational research

Complete TMS solution for animal model research

MagVenture's offers a specifically dedicated coil for animal model research. It provides a unique opportunity to study the effects of TMS within a wide range of fields including behavioral, metabolic, (epi) genetics, molecular, and biochemical pathways. This research solution overcomes previously known challenges pertaining to focality, overheating, shape, and size. It provides complete replicability and reliability and, due to the small coil size, it will even fit inside a PET or SPECT imaging scanner.

Recommended solution for animal model research

- **Stimulators:** R30, R30 MO, X100 or X100 MO depending on application
- **Coil:** Cool-40 Rat Coil
- **Accessory:** High-Performance Coil Cooling System

Want to do research on larger animals?

MagVenture offers a range of slightly larger coils which are also suitable for translational research - for example the B35 or MCF-75. Contact us for more details.

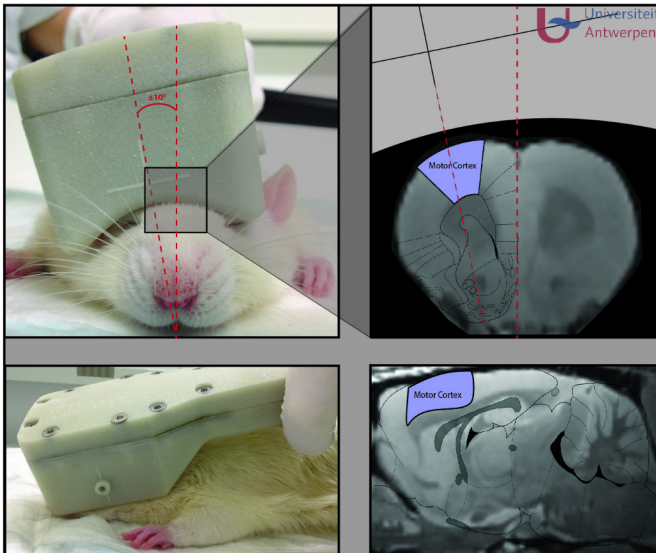

The Cool-40 Rat Coil was originally developed with researchers at Antwerp University who were seeking to unravel the mechanism of action for TMS as well as test new paradigms.

More than 20 Cool-40 Rat Coils are used globally for high-end translational research. So far, 3 studies have been published.



Tailored research solutions

Your idea today – a new neuromodulation tool for your lab tomorrow?

Responding to researchers' ideas and requests has been a vital part of the MagVenture DNA for three decades. This has resulted in numerous "first mover" solutions, spanning from brand new coils, theta burst stimulation, and extraordinarily efficient cooling systems for highly demanding protocols.

Contact us to hear more about the possibilities for bringing your idea to life.

Customized coil solutions - examples



Covid-19 research

When the Covid-19 pandemic first took hold of Europe in early 2020, MagVenture was contacted by a researcher at a leading UK university who was looking for ways to shorten patients' time on ventilation and speed up post-recovery. The idea was to stimulate the phrenic nerve to keep the diaphragm active. Within a few weeks, MagVenture had developed the first prototype of a brand new coil: the Twin B46.

The coil has now found its way to Brazil where Professor Dr. Abrahão Baptista has been pioneering research with the use of TMS in respiratory patients. He is now testing this new solution at the university of São Paulo as part of a study on non-invasive brain stimulation on respiratory patients, including Covid-19.



Stimulate two brain regions at close proximity

Based on input from researchers, MagVenture developed an asymmetrical coil – the Cool-D50 – enabling alternating stimulation of two centers in the brain only 2-3 cm apart.



Demanding TMS protocols in MRI scanners

MagVenture had already developed an MRI-coil for use inside an MRI scanner. An air cooled version of the coil has since been developed, allowing even longer and tougher protocols.

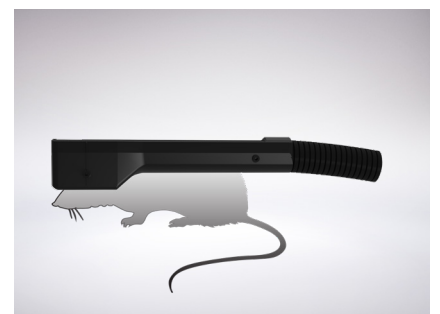

Stimulating rodents

At the request of Antwerp University, and in close collaboration with the researchers, a designated coil for stimulating rodents was developed, resulting in new studies within animal model research.

Stimulate multiple sites at the same time

MagVenture offers a large range of smaller research coils allowing for stimulation at multiple sites on the brain at the same time

The small geometry of the B35 coil enables you to place multiple coils simultaneously on the head providing a focal, yet powerful stimulation. The B35 coil comes in different versions to suit your specific needs.

- MC-B35
- Cool-B35
- Cool B35-HO (with handle turning upwards for easy coil placement)
- Cool-B35 RO (Robotic edition to be used with the Axilum robot)

Another option is the D-shaped Cool-D50 coil with the stimulation center being placed at the edge of the coil. This allows for alternating stimulation of two centers in the brain only 2-3 cm apart.

Smaller circular coils like the MMC-90 coil or MCF-75 coil are also available for less selective stimulation, but still allow for multiple coils to be placed close to one another.

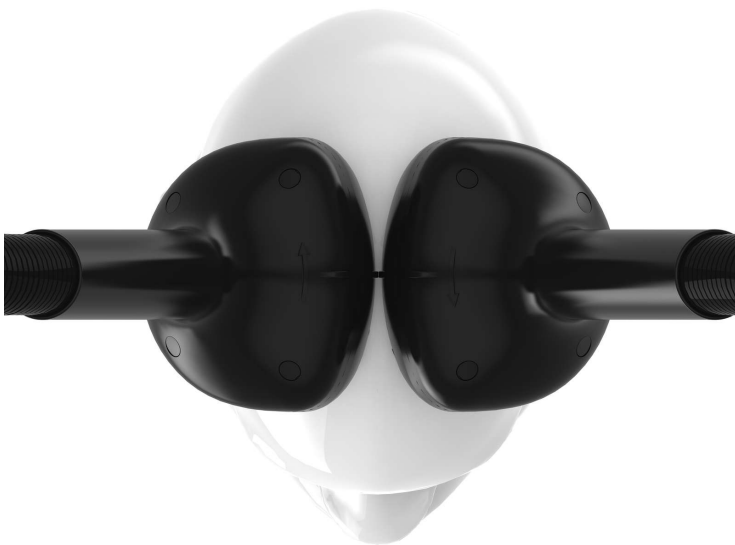

Recommended research solutions for dual or multi-site stimulation

- **Stimulators:** R30 with MagOption or X100 with MagOption combined with a smaller stimulator such as the R20 or the Compact
- **Coils for repetitive stimulation:**
Cooled coils: Cool-D50, Cool-B35, Cool-B35 HO, Cool-B35 RO
- **Coils for single stimulation:**
Static/non-cooled coils: MCF-75, MC-B35, MMC-90
- **Accessory:** High-Performance Coil Cooling System

Introducing the XP: MagVenture's most powerful stimulator

MagVenture's XP Orange Edition is capable of delivering 250 pps, more than twice the power of a standard stimulator. This, by far, exceeds any other stimulator currently available. The XP Orange Edition is the first TMS device to bridge the gap between electrophysiological memory models and TMS, using the same frequency as the human brain.

Thanks to its fully integrated, superior coil cooling you can run the most demanding research protocols with no issues of coil overheating. Ever.

The XP Orange Edition stimulator comes as a fully encased, integrated system with a practical console design which makes transportation between labs easy.

- Larger frequency range than standard stimulator
- Optimized for interleaved TMS/fMRI
- Flexible operation with movable screen
- Improved durability



Sneak peak into the future

Developing new neuromodulation research tools

MagVenture's R&D department is always working on developing future solutions to unlock the unsolved mysteries of the brain and the central nervous system. This is just a small sneak peak into some of MagVenture's many current projects.



Multi-channel stimulation
Several channels to allow for the investigation of complex functional inter-connectivity of the brain and the central nervous system.



Combined EEG and TMS
A window into the neurophysiological effects of TMS.

























Dual stimulation
Dual monophasic stimuli of high intensity and low time interval using two individual coils.

Stimulator overview

Whether your interest lies within the translational, investigational, diagnostic, or the neurophysiological field, a stimulator from MagVenture will meet your exact requirements. User defined protocols, storage and retrieval of protocols, automatic sequence set-up, transferable data, advanced in/out triggers for EEG, EMG, and EP equipment are among the many features to ease your workflow, and ensure accuracy and consistency in your research.

With 7 different MagPro stimulators to choose from, all of which can be used in combination with neuronavigation and/or robotic TMS, MagVenture offers a unique diversity in stimulators and make otherwise impossible research possible.

		Hi-end			Mid-level		Basic	
								
		XP Orange	X100 MO	X100	R30 MO	R30	R20	Compact
								
								
								
Maximum Repetition Rate	250 pps	•						
	100 pps		•	•				
	80 pps					• *		
	60 pps					• **		
	30 pps				•	•		
	20 pps						•	
Pulse Mode	5 pps							•
	Power Mode		•					
Waveform	Dual/Twin		•		•			
	Standard	•	•	•	•	•	•	•
Waveform	Biphasic	•	•	•	•	•	•	•
	Biphasic Burst (Theta Burst)	•	•	•		• ***		
	Monophasic		•	•	•			
	Half-Sine		•					
Current Direction	Normal and Reverse		•	•				
Sham noise	(Add-on)	•	•	•	•	•		

* With 80 pps option | ** With 60 pps option | *** With TBS option.



= MRI compatible



= Can be used with the MagVenture Double-Blinded Research software



= Translational research compatible

Coil overview

With numerous coils to choose from, whether you want to stimulate higher-lying targets such as DLPFC or reach deeper-lying structures, MagVenture provides you with endless possibilities. All TMS coils come in various shapes and sizes and with different attributes such as cooling, power control, and triggering in the handle.

MagVenture's extremely efficient liquid cooling will let you run even the most aggressive protocols, and a higher number of repetitions without the need for coil change. Depending on the needed number of pulses and intensity, MagVenture offers different cooling solutions from static cooling to the more efficient liquid cooling and even a high performance cooling option for extreme protocols and/or small coils.

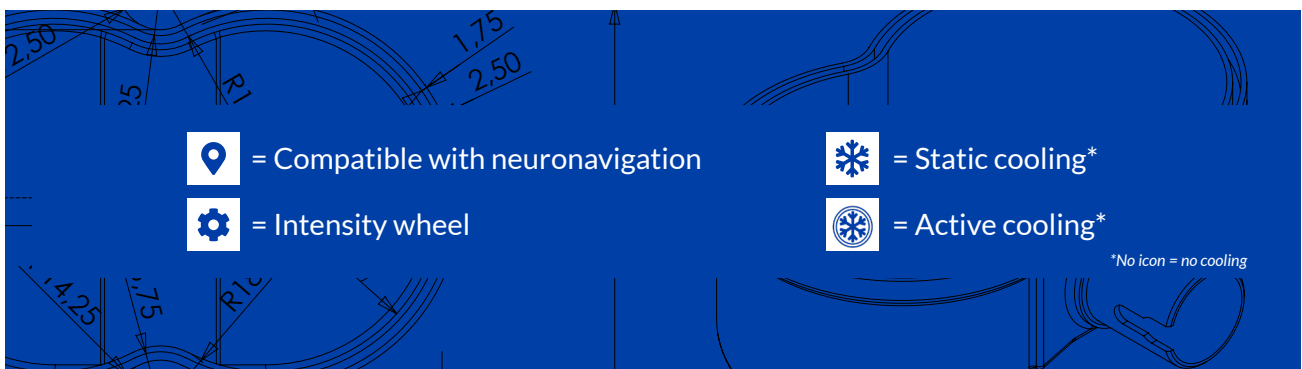

NOTE: All coil magnetic field data listed in this publication is for comparison purpose only. Some of the data is simulated and some is measured. For more information on a specific coil please contact us.

Circular coils

The circular coils stimulate fairly large areas. The stimulation is strongest between the outer edge and the center of the coil. Circular coils come in various sizes and shapes, including elliptic.



C-100

Outer diameter:
 \varnothing 123 mm/4.84 in.

Penetration depth (70 v/m):
 39.6 mm/1.56 in.

Magnetic field:
 Peak at coil surface: 2.4 T
 Gradient at 20 mm: 21 kT/s



MC-125

Outer diameter:
 \varnothing 130 mm/5.12 in.

Penetration depth (70 v/m):
 38.5 mm/1.52 in.

Magnetic field:
 Peak at coil surface: 1.6 T
 Gradient at 20 mm: 18 kT/s



MMC-90

Outer diameter:
 \varnothing 95x22/3.74x0.87 in., convex

Penetration depth (70 v/m):
 34 mm/1.34 in.

Magnetic field:
 Peak at coil surface: 2.6 T
 Gradient at 20 mm: 14 kT/s



MMC-140 II

Outer diameter:
 ø143x14.5 mm/5.63x0.57 in.

Angle: Concave

Penetration depth (70 v/m):
 44.3 mm/1.74 in.

Magnetic field:
 Peak at coil surface: 2.0 T
 Gradient at 20 mm: 18 kT/s



MCF-75

Outer diameter:
 ø88 mm/3.46 in.

Penetration depth (70 v/m):
 26.7 mm/1.05 in.

Magnetic field:
 Peak at coil surface: 3.2 T
 Gradient at 20 mm: 15 kT/s



MCF-125

Outer diameter:
 ø140 mm/5.51 in.

Penetration depth (70 v/m):
 39.2 mm/1.54 in.

Magnetic field:
 Peak at coil surface: 1.6 T
 Gradient at 20 mm: 16 kT/s



Cool-125

Outer diameter:
 ø140 mm/5.51 in.

Penetration depth (70 v/m):
 37.7 mm/1.48 in.

Magnetic field:
 Peak at coil surface: 1.5 T
 Gradient at 20 mm: 16 kT/s



Cool-40 Rat Coil

Outer diameter:
 52x54 mm/2x2.1 in.

Penetration depth (70 v/m):
 11 mm/0.43 in.

Magnetic field:
 Peak at coil surface: 7.5 T
 Gradient at 20 mm: 19 kT/s



RT-120

Outer diameter:
 ø90x185 mm/3.15x7.28 in.

Penetration depth (70 v/m):
 35.2 mm/1.38 in.

Magnetic field:
 Peak at coil surface: 1.15 T
 Gradient at 20 mm: 15 kT/s

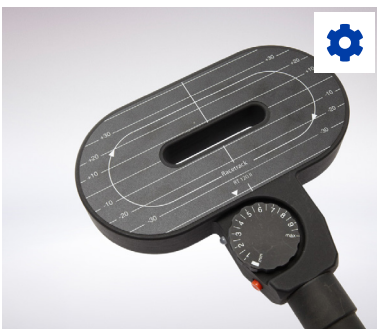

RT-120-II

Outer diameter:
 ø90x172 mm/3.54x6.78 in.

Penetration depth (70 v/m):
 35.2 mm/1.38 in.

Magnetic field:
 Peak at coil surface: 1.15 T
 Gradient at 20 mm: 15 kT/s

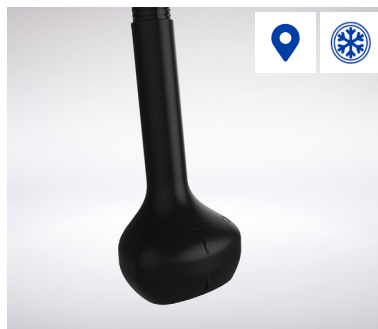

Cool-D50

Outer diameter:
 111x94 mm/4.4x3.7 in.

Penetration depth (70 v/m):
 30.7 mm/1.21 in.

Magnetic field:
 Peak at coil surface: 1.9 T
 Gradient at 20 mm: 16 kT/s

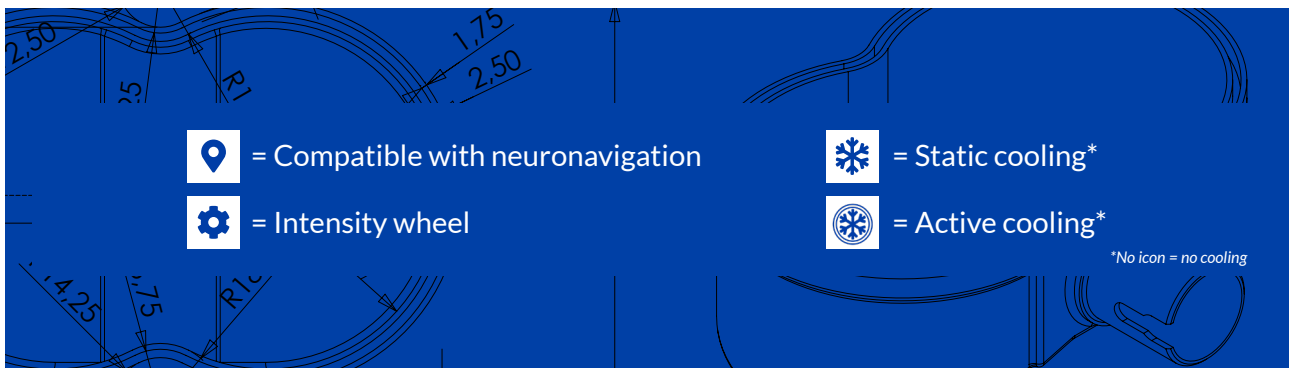

Butterfly coils

The Butterfly coils are used for focused stimulation, with the windings placed side-by-side providing the strongest stimulation right under its center.

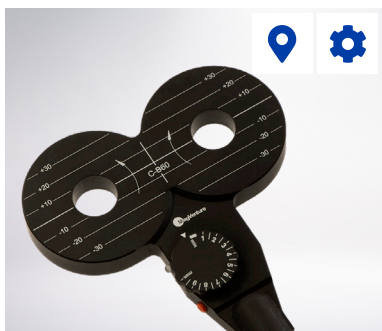

C-B60

Outer diameter:

165x85 mm/6.5x3.35 in.

Penetration depth (70 v/m):

31.5 mm/1.24 in.

Magnetic field:

Peak at coil surface: 1.4 T

Gradient at 20 mm: 9 kT/s



C-B70

Outer diameter:

170 x 113 mm/6.69 x 4.45 in.

Angle: 150°

Penetration depth (70 v/m):

37.3 mm / 1.47 in.

Magnetic field:

Peak at coil surface: 1.9 T

Gradient at 20 mm: 15kT/s



D-B80

Outer diameter:

196x106 mm/7.7x4.17 in.

Angle: 120°

Penetration depth (70 v/m):

42.7mm/1.68 in.

Magnetic field:

Peak at coil surface: 1.0 T

Gradient at 20 mm: 12 kT/s



MC-B35

Outer diameter:

103x55 mm/4.05x2.16 in.

Penetration depth (70 v/m):

27.5 mm/1.08 in.

Magnetic field:

Peak at coil surface: 2.8 T

Gradient at 20 mm: 10 kT/s



MC-B65 HO

Outer diameter:

165x85 mm/6.5 x 3.35 in.

Penetration depth (70 v/m):

32.7 mm/1.29 in.

Magnetic field:

Peak at coil surface: 1.4 T

Gradient at 20 mm: 9 kT/s



MC-B70

Outer diameter:

169x112 mm/6.65x4.40 in., 150°

Penetration depth (70 v/m):

37.3 mm/1.47 in.

Magnetic field:

Peak at coil surface: 1.9 T

Gradient at 20 mm: 15 kT/s



MCF-B65

Outer diameter:
172x92 mm/6.9x3.7 in.

Penetration depth (70 v/m):
31.5 mm/1.24 in.

Magnetic field:
Peak at coil surface: 1.4 T
Gradient at 20 mm: 9 kT/s



MCF-B70

Outer diameter:
180x116 mm/7.1x4.6 in.

Angle: 150°
Penetration depth (70 v/m):
34.0 mm / 1.34 in.

Magnetic field:
Peak at coil surface: 1.4 T
Gradient at 20 mm: 12 kT/s



Cool-B35

Outer diameter:
113 x 65 mm /4.4 x 2.6 in.

Penetration depth (70 v/m):
23.1 mm/0.9 in.

Magnetic field:
Peak at coil surface: 2.1 T
Gradient at 20 mm: 7 kT/s



Cool-B35 HO

Outer diameter:
113x65 mm /4.4x2.6 in.

Penetration depth (70 v/m):
23.1 mm / 0.9 in.

Magnetic field:
Peak at coil surface: 2.1 T
Gradient at 20 mm: 7 kT/s



Cool-B65

Outer diameter:
172x92 mm/6.8x3.6 in.

Penetration depth (70 v/m):
31.5 mm/1.24 in.

Magnetic field:
Peak at coil surface: 1.4 T
Gradient at 20 mm: 9 kT/s



Cool D-B80

Outer diameter:
215x110 mm/8.5x4.3 in.

Angle: 120°
Penetration depth (70 v/m):
41.8 mm /1.65 in.

Magnetic field:
Peak at coil surface: 1.0 T
Gradient at 20 mm: 11 kT/s



Cool-B70

Outer diameter:
180x116 mm/7.1x4.6 in.

Penetration depth (70 v/m):
34.0 mm / 1.34 in.

Magnetic field:
Peak at coil surface: 1.4 T
Gradient at 20 mm: 12 kT/s

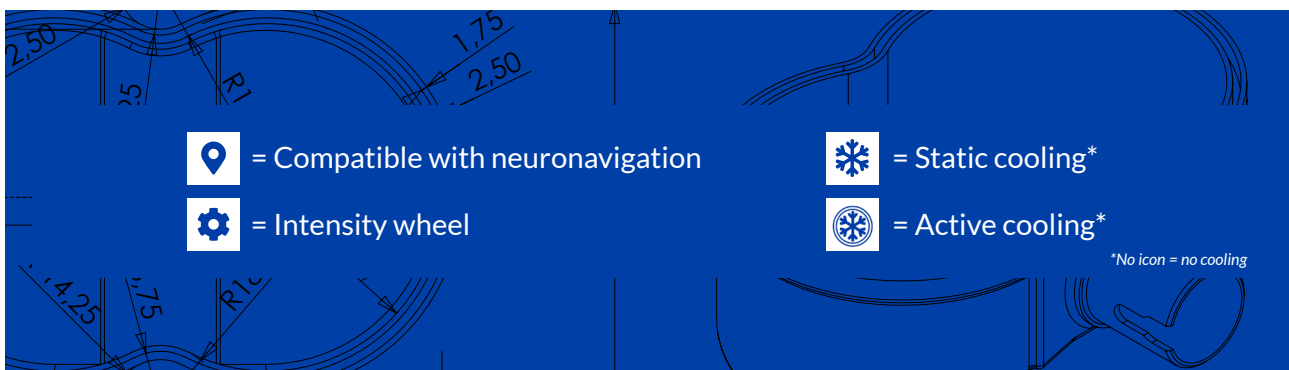

Clinical Research

A number of coils have been specifically developed for clinical research. Some are for single-blinded placebo studies (P), others for true double-blinded research studies with both an active and a placebo side (A/P). The range of active/placebo coils delivers a magnetic field on the placebo side that is <5% of the active side. The placebo coils have a magnetic field reduction of more than 80% of the field of the correspondent coil.



Cool-B70 A/P

Outer diameter:
173x116 mm/6.8x4.6 in.

Angle: 150°

Penetration depth (70 v/m):
34.0 mm/1.34 in. (active side)

Magnetic field (active side):
Peak at coil surface: 1.4 T
Gradient at 20 mm: 12 kT/s



Cool D-B80 A/P

Outer diameter:
220x115 mm/8.7x4.5 in.

Angle: 120°

Penetration depth (70 v/m):
41.8 mm/1.65 in. (active side)

Magnetic field (active side):
Peak at coil surface: 1.0 T
Gradient at 20 mm: 12 kT/s



MMC-140 A/P

Outer diameter:
ø145 mm/5.7 in

Angle: Concave

Penetration depth (70 v/m):
44.3 mm /1.74 in. (active side)

Magnetic field (active side):
Peak at coil surface: 2.0 T
Gradient at 20 mm: 18 kT/s



Cool-B65 A/P

Outer diameter:
172 x 92 mm/6.8x3.6 in

Penetration depth (70 v/m):
31.5 mm /1.24 in. (active side)

Magnetic field (active side):
Peak at coil surface: 1.4 T
Gradient at 20 mm: 9 kT/s



MCF-P-B65

Outer diameter:
174x94 mm/6.8x3.7 in

Magnetic field:
See above.



MC-P-B70/ MCF-P-B70

Outer diameter:
169x112 mm/6.7x4.4 in./
180x116 mm/7.1x4.6 in.

Angle: 150°

Magnetic field:
See above.

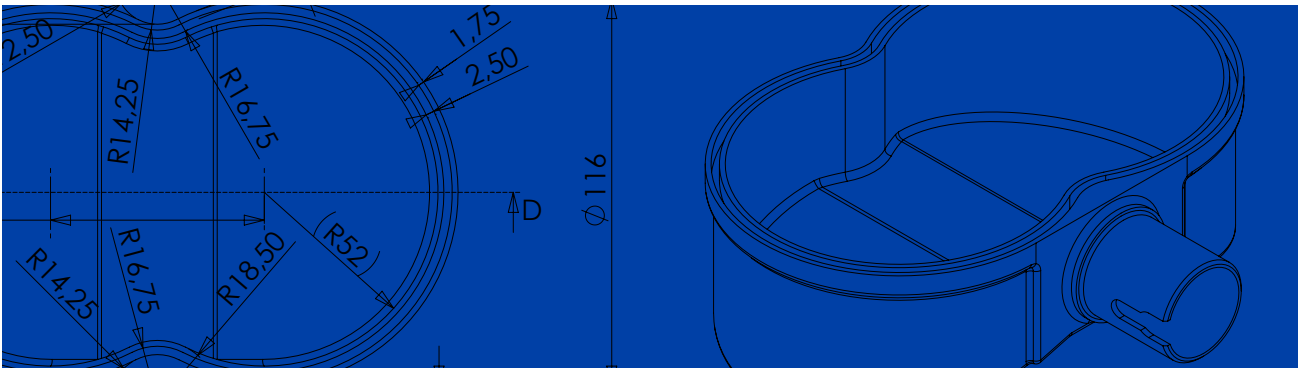

Robotic TMS

A selection of our coils also come in a robotic/cobotic edition.



Cool-B65 RO

Outer diameter:
172x92 mm/6.8x3.6 in.

Penetration depth (70 v/m):
31.5 mm/1.24 in.

Magnetic field:
Peak at coil surface: 1.4 T
Gradient at 20 mm: 9 kT/s



Cool-B65 CO

Outer diameter:
172x92 mm /6.8x3.6 in.

Penetration depth (70 v/m):
31.5 mm/1.24 in.

Magnetic field:
Peak at coil surface: 1.4 T
Gradient at 20 mm: 9 kT/s



Cool-B35 RO

Outer diameter:
113 x 65 mm/4.4x2.6 in.

Penetration depth (70 v/m):
23.1 mm/0.9 in.

Magnetic field:
Peak at coil surface: 2.1 T
Gradient at 20 mm: 7 kT/s



Cool-B65 A/P RO

Outer diameter:
172x92 mm/6.8x3.6 in.

Penetration depth (70 v/m):
31.5 mm/1.24 in. (active side)

Magnetic field:
Peak at coil surface: 1.4 T
Gradient at 20 mm: 9 kT/s
Placebo side: <5% of active side







Cool-B65 A/P CO

Outer diameter:
172 x 92 mm/6.8x3.6 in.

Penetration depth (70 v/m):
31.5 mm/1.24 in. (active side)

Magnetic field:
Peak at coil surface: 1.4 T
Gradient at 20 mm: 9 kT/s
Placebo side: <5% of active side

 = Compatible with neuronavigation
 = Intensity wheel
 = Static cooling*
 = Active cooling*
*No icon = no cooling

MRI

Coils for interleaved TMS/fMRI, when stimulating inside an MR scanner.



MRI-B91

Outer diameter:

172x92 mm/6.8x3.6 in.

Penetration depth (70 v/m):

31.5 mm/1.22 in.

Magnetic field:

1.4 T or 36kT/s



MRI-B91 Air Cooled

Outer diameter:

172 x 92 mm/6.8 x 3.6 in.

Penetration depth (70 v/m):

31.1 mm/1.22 in.

Magnetic field:

Peak at coil surface: 0.8T

Gradient at 20 mm: 8 kT/s

Note:

This coil is air cooled, not liquid cooled.





About MagVenture®

MagVenture is a Danish medical device manufacturer of magnetic stimulation solutions. MagVenture develops and markets advanced medical equipment based on the use of pulsating magnetic fields used for clinical examination as well as for research within psychiatry, neurophysiology, neurology, cognitive neuroscience, and rehabilitation. With 7 different magnetic stimulators and over 35 different coils, MagVenture can provide a solution to most needs within neuromodulation research.

MagVenture's mission is to be the most dynamic and innovative supplier of transcranial magnetic stimulation solutions. Many "first mover" features and improvements have been developed over the years in response to ideas and requests from its customers. MagVenture's stimulators are sold on the world market through direct sales subsidiaries in the USA, Germany, the UK, and Brazil, and through a global network of distributors in Europe, Asia, the Middle East, and the Americas.

www.magventure.com

All products are developed and manufactured in accordance with the standard ISO 13485:2012, the current EU Medical Device Directive, the Canadian Medical Devices Regulation (CMDR), US 21 CFR 820 for the USA, and in accordance with a number of additional country-specific regulations. MagPro stimulators and coils are approved as medical devices in Europe, the USA, Canada, China, Japan, South Korea, Australia, Russia, and other markets worldwide. MagVenture®, MagPro®, and MagVenture TMS Therapy® are registered trademarks of MagVenture A/S. Please note that not all stimulators, coils, and accessories are cleared for sale in the USA by the Food and Drug Administration (FDA). Please also note that in the USA, Transcranial Magnetic Stimulation is considered investigational - except for the cleared intended use for treatment of Major Depressive Disorder in adult patients who have failed to receive satisfactory improvement from prior antidepressant medication in the current episode and as an adjunct for the treatment of adult patients suffering from Obsessive-Compulsive Disorder.

Please note that the stimulators, features, coils, and accessories described in this brochure may not all be available and/or approved by the regulatory authorities in your country/region. For more information, please consult with your local MagVenture distributor or subsidiary. Delivery times may vary.